

Installation Instructions

603 DECT Intercom

PROFESSIONAL INSTALL ONLY

Do NOT give this manual to end user!

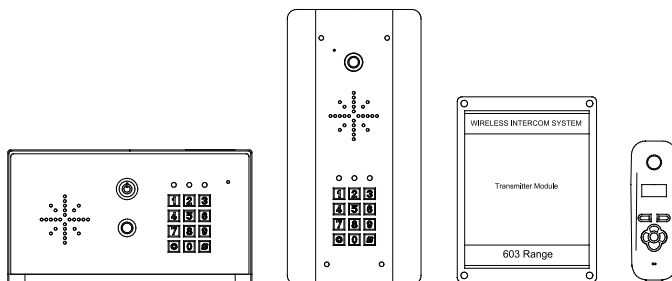

Models 603-IBK, AB, ABK, HB, HBK, FB, FBK, IMP, IMPK

The manufacturer cannot legally offer technical support to non-qualified gate or door installers. End users should employ the services of a professional install company to commission or support this product!



Tip: Site Survey BEFORE you begin. See Page 3!



WARNING

Do not power from the gate controller. Only use the provided UL power supply, otherwise damage may occur and warranty may be void.



Contents

Overview of SystemPg 3
Site SurveyPg 3
Wall / Pillar MountingPg 3
Gooseneck / Pedestal MountingPg 4
Mounting Speech PanelsPg 5
WiringPg 6
Keypad OverviewPg 7
Keypad ProgrammingPg 7
Using the KeypadPg 9
The HandsetPg 9
Re-coding or Adding a HandsetPg 10
TestingPg 10
Using the HandsetPg 10
Adjusting Relay TimePg 11
Adjusting Handset Displayed TimePg 11
VoicemailPg 11
Troubleshooting GuidePg 11

Overview of System

Please read this entire manual before attempting to install this system.

This system should only be installed by a professional automatic gate installer or access control specialist installer.

It is recommended that the system be range tested on site **BEFORE** being fully installed.

Site Survey

Before installing this system, you need to be sure that the range of the system will be sufficient.

The transmitter and speech unit can be powered up, call button pressed, and then check that the handset will ring from all areas in which it will be used.

Wall/Pillar Mounting

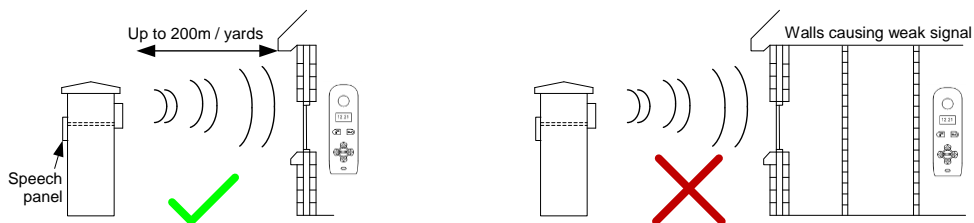

Tip: For longer range installations, locate the handset close to the front of the property, near a window if possible. Concrete walls can reduce the open-air range of 400 metres/yards by 30-50% per wall.

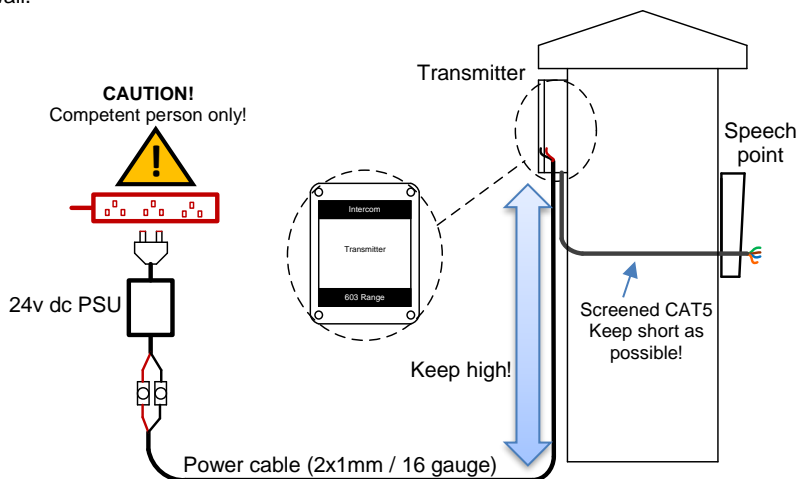

TIP: Most technical calls received are due to installers using CAT5 or alarm cable to power the unit. Neither are rated to carry enough power (1.2 amp peak). Please use following cable...

Up to 2 metres (6 feet) – Use minimum 0.5mm² (20 gauge)

Up to 4 metres (12 feet) – Use minimum 0.75mm² (18 gauge)

Up to 8 metres (24 feet) – Use minimum 1.0mm² (16 gauge)

Gooseneck / Pedestal Mounting

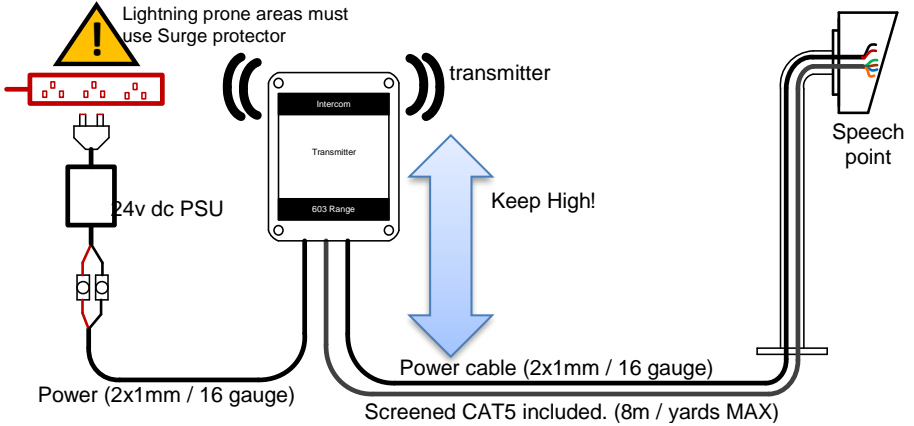

Tip: For shorter distances, some installs may mount transmitter on pedestal for convenience. Range test first! For high security applications, it is recommended to locate the transmitter **INSIDE** the property perimeter.

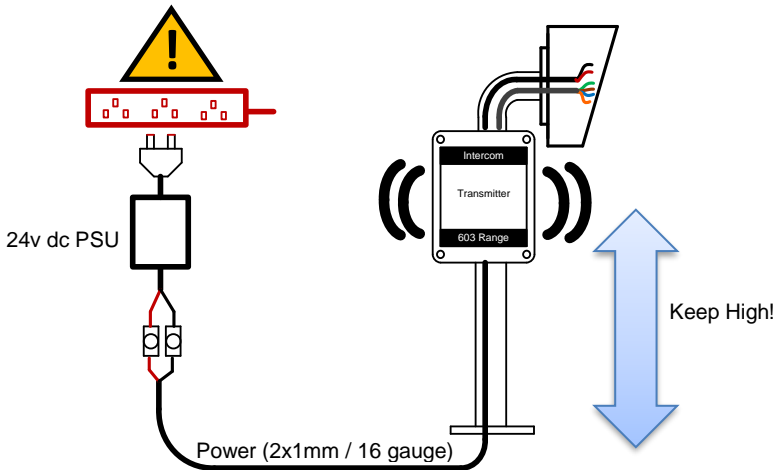

TIP: Most technical calls received are due to installers using CAT5 or alarm cable to power the unit. Neither are rated to carry enough power (1.2 amp peak). Please use following cable...

- Up to 2 metres (6 feet) – Use minimum 0.5mm² (20 gauge)
- Up to 4 metres (12 feet) – Use minimum 0.75mm² (18 gauge)
- Up to 8 metres (24 feet) – Use minimum 1.0mm² (16 gauge)

Mounting Architectural Panels

Loosen top 2 screws only

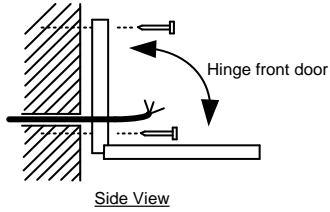
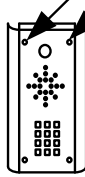

Mounting Hooded Panels

Loosen top 2 screws only

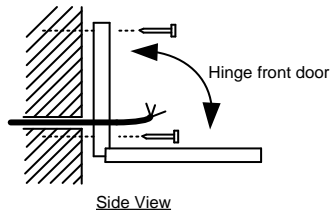
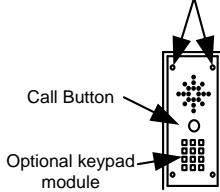

Mounting Flush Panels

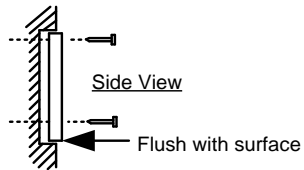
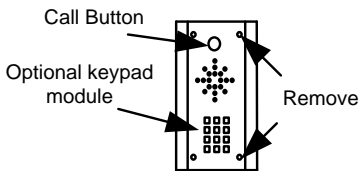

Tip: Use appropriate fixings to ensure the intercom cannot be removed from the wall.

Pedestal Style Mounting

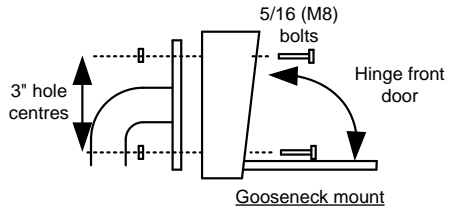
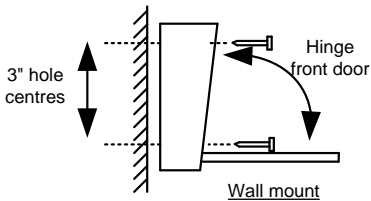

Tip: Use key provided to unlock front door.

Wiring

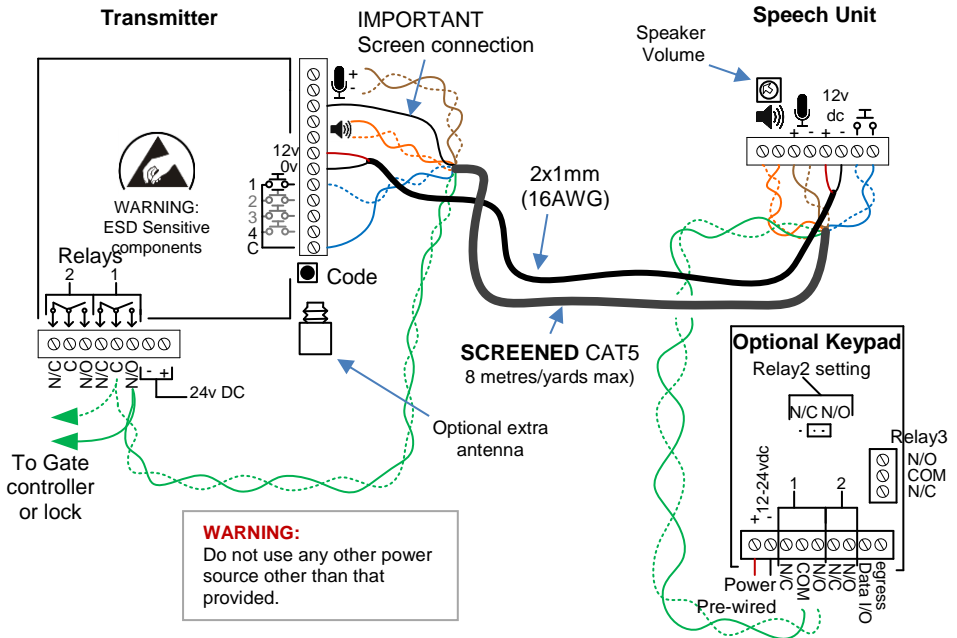

Output Connections Example

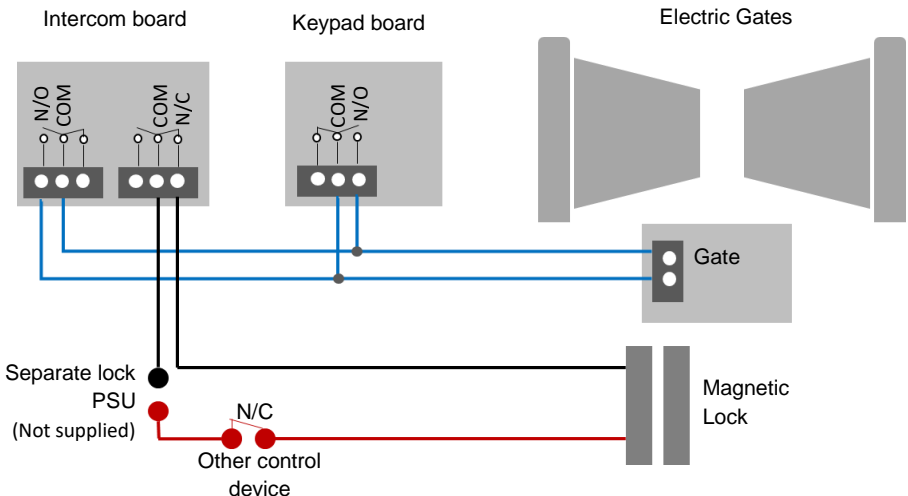

Keypad overview

This keypad has 3 outputs. The diagram below shows the LED indicators which indicate programming and relay status information.

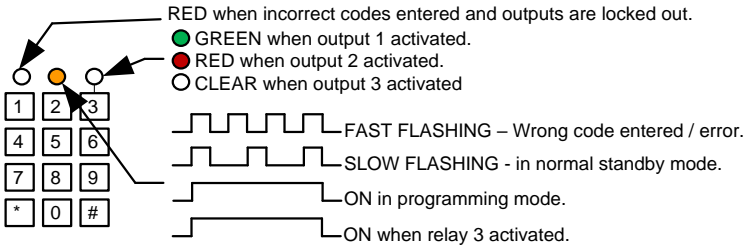

TIP: After power up, as a security precaution, the keypad cannot be programmed for 60 seconds. Once this time elapses, you may begin.

TIP: Flashing amber LED is normal standby mode!

Basic Keypad Programming

Quick start guide

1) Enter programming mode (amber LED should be ON)

0 0 0 0 * *

2) Enter a new user code...

1 0 2 0 0 0 ? ? ? ? #

3) Exit programming mode

* *

4) Enter the new user code to check the relay clicks.

Tip: The engineer code must be the same length as user codes. So if using a 6 digit engineers code, then user codes must also be 6 digits long etc.

Full Keypad programming

Enter programming mode..

0 0 0 0 * *

The unit is now in programming mode. Amber LED on the keypad should remain permanently on. 0000 is the default programming passcode.

Exit programming mode..

* *

The unit should exit programming mode and the amber LED should start flashing again.

Enter a new ENGINEERS code...

Go into programming mode firstly then enter the following sequence...

0 1 ? ? ? ? #

Location

4-8 digit code

Validate

Replace ???? with your new ENGINEERS code.

Enter or delete new user codes

There are 3 groups of user codes. Group 10 for relay 1, group 20 for relay 2, and group 30 for relay 3. The programming sequence is shown below...

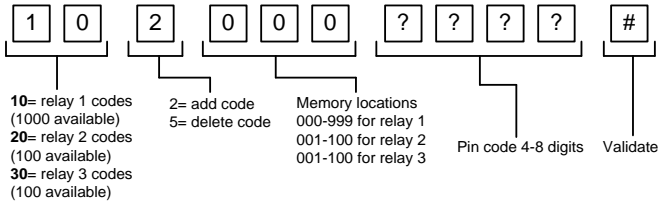

Example: Add user 31 to have access code 5555 operating relay 2....

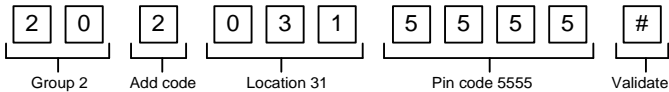

Programming relay output times and modes...

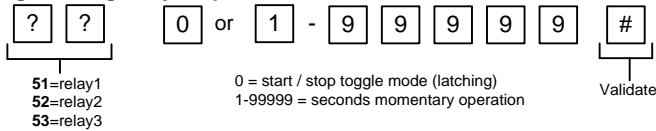

Delete a user code even if you don't know the code...

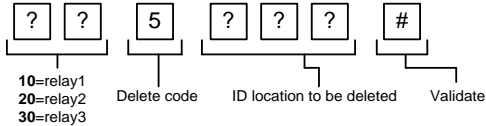

Delete an entire group of codes

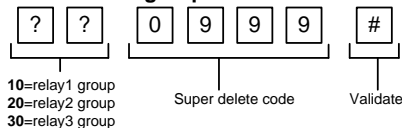

Programming super user codes...

A super user code can activate any of the 3 relays

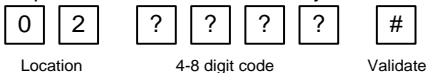

Restoring defaults

When in programming mode, you can enter the following sequence...

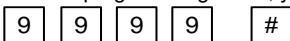

When the master code is forgotten....

- 1) Wire a push button (or replicate with wire link) across the Egress terminal and (-)GND.
- 2) Switch off power for 1 minute.
- 3) Switch ON power.
- 4) during the first 60 seconds, press the EG button once to enable the function.
- 5) Enter the following code..

8 0 8 0 * *

The keypad should now be in programming mode, ready to accept new data. The master code will need changed at this point to something memorable before proceeding.

Using the keypad

Using the standard codes...

Once you have exited out of programming mode, simply enter the user code.

Using super user codes

? ? ? ? # 1 Activate output 1
? ? ? ? # 2 Activate output 2
? ? ? ? # 3 Activate output 3

The Handset

The handset should be charged for 8 hours before use. It is recommended to give it at least 1 hour charge before range testing.

Ring Another Handset

Press \triangleright and the unit will display HS1-5 depending on how many handsets are coded. Press ∇ and \triangle to select and then OK to call that handset.

Voicemail

When a call is not answered within 40 seconds, the visitor can leave a message. Once complete, the handset will display the ✉ symbol. The unit can store up to 16 messages.

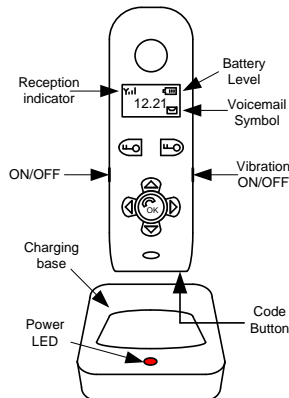

Change Ring Volume

Press \triangle and ∇ to increase and decrease ring volume and press OK to save.

Change Ring Tone

Press \triangleleft and the handset will ring with its currently selected tone. Press \triangle and ∇ to cycle through available ring tones and press OK to select and save.

To listen to voicemail, press OK to play. If there are more than 1 message, press \triangle and ∇ to select the message required and press OK to play. ✖ = Delete (Relay 1). Long press = delete all.

Re-coding Handset/Adding Extra Handset

Occasionally a system may need re-coded once installed. If the handset does not ring when the call button is pressed, it may need re-coded. The procedure for doing this is the same as for adding an additional handset as follows...

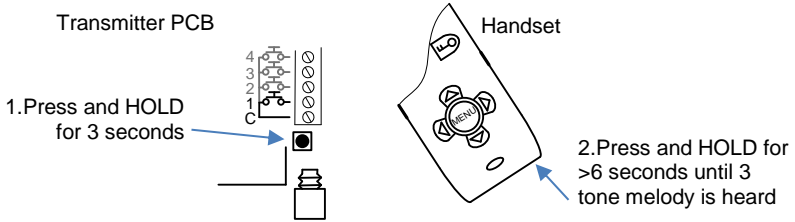

Once the melody is heard, the handset should then be working. The system should now be ready for testing.

Testing

Press the call button on the intercom and all coded handsets should ring (max 4 handsets).

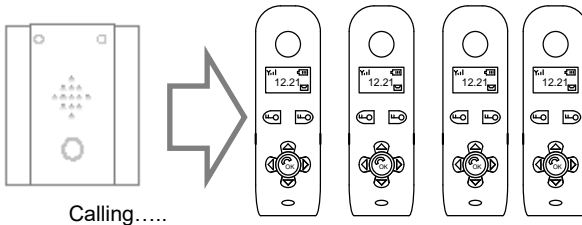

Answer the call on any handset by pressing , and check for good 2 way speech. Adjust volume while on a call with up and down arrow buttons on the handset and press the same button again to end the call. The gate/door release button can be pressed at any time, either while on or off a call. The relay on the transmitter should then pulse on for 4 seconds.

Using the intercom Handset

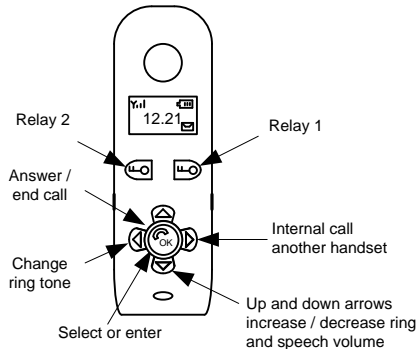

Adjusting Relay time

Press Relay 2 button for 3 seconds, scroll through menu until you see 'ti'. Press OK to select 'ti' and adjust your relay times. Press OK to select your relay time. Press the right arrow end the process. Both relays will have the same relay time.

Adjusting time on Handset

Press OK for more than 2 seconds, and then use up and down arrow keys to set hour. Press OK again to cycle to minutes and adjust. Press OK once more to end the process.

Voicemail

To turn your voicemail ON, press and hold Relay 2 button for 3 seconds, scroll through the menu until you see 'Re'. Press OK to select 'Re' and adjust your setting to ON or OFF. Press OK to select. Press the right arrow end the process.

Troubleshooting guide

Q. The unit will not ring the handset.

A. Try re-coding the handset and transmitter as per instructions.

- Check push button wiring to the transmitter with multi-meter.

-Check power cable distance from power adaptor to transmitter is less than 4 metres.

Q. The person on the handset can hear interference on the call.

A. Check cable distance between the speech unit and transmitter. Shorten this if possible.

-Check cable used between the speech unit and transmitter is screened CAT5.

-Check that the screen of the CAT5 is connected to ground in the transmitter as per wiring instructions.

Q. Keypad code not operating the gate or door

A. Check if the corresponding relay indicator light comes on. If it does, then the fault is either a power problem with excessive cable run, or wiring. If the relay can be heard clicking, then it is a wiring problem. If a click cannot be heard, then it is likely a power problem. If the light does not activate and the keypad emits an error tone, then the issue is likely a programming error.

Q. My handset will not recode

Try the process again. If it still does not work, delete the code from the transmitter. To delete code, press the code button for 3 seconds and release. Then press it 7 times after which a tone should be heard. Then press another 7 times. Now try re-coding the handset again as per the procedure.

Q. Range problem – Handset works beside the intercom, but not from inside the building

A. Check that the power cable to the transmitter is within guidelines and is heavy enough gauge.

Insufficient power cabling will reduce transmission power! Check that there are not excessive objects blocking the signal, like large dense shrubs, vehicles, foil lined wall insulation etc. Try to achieve line of sight between both devices.

Q. No speech in either direction

A. Check CAT5 wiring between speech panel and transmitter. Disconnect, re-strip cables and re-connect again.

Q. Handset will not charge

A. Try replacing both batteries with equivalent Ni-Mh batteries firstly. It is possible to have a dead cell in a battery which can prevent both batteries from charging.

-Check for contamination or grease on the charging pins at the base of the handset (gently scratch with screwdriver or wire wool).

Regulatory Compliance



FCC Id: 2ALPX-603TX and 2ALPX-603EH

Grantee: Advanced Electronic Solutions Global Ltd

This device complies with Part 15D of FCC rules. Operation is subject to the following two conditions: (1) this device may not cause harmful interference, and (2) this device must accept any interference received, including interference that may cause undesired operation.

Output power listed is conducted. This device must be installed to provide a separation distance of at least 20 cm from all persons and must not be co-located or operating in conjunction with any other antenna or transmitter. End-users and installers must be provided with antenna installation instructions and transmitter operating conditions for satisfying RF exposure compliance. This device has 20MHz and 40 MHz bandwidth modes.

EU-RED Declaration of Conformity

Manufacturer: Advanced Electronic Solutions Global Ltd

Address: Unit 4C, Kilcronagh Business Park, Cookstown, Co Tyrone, BT809HJ, United Kingdom

We/I declare, that the following equipment (DECT intercom), part numbers:

603-EH, 603-TX

Multiple Models: 603-AB, 603-ABK, 603-AB-AU, 603-ABK-AU, 603-ABP, 603-AS, 603-AS-AU, 603-ASK, 603-ASK-AU, 603-BE, 603-BE-AU, 603-BEK, 603-BEK-AU, 603-EDF, 603-EDG, 603-HB, 603-NB-AU, 603-HBK, 603-HBK-AU, 603-HS, 603-HSAU, 603-HSK, 603-HSK-AU, 603-IB, 603-IBK, 603-IBK-AU, 603-IBK-BFT-US, 603-IB-BFT-US, 703-HS2, 703-HS2-AU, 703-HS3, 703-HS3-AU, 703-HS4, 703-HS4-AU, 703-HSK2, 703-HSK2-AU, 703-HSK3, 703-HSK3-AU, 703-HSK4, 703-HSK4-AU

Complies with the following essential requirements:

ETSI EN 301 489-1 V2.2.0 (2017-03)

ETSI EN 301 489-6 V2.2.0 (2017-03)

ETSI EN 301 406 V2.2.2 (2016-09)

EN 62311:2008

EN 62479:2010

EN 60065



Australia / New Zealand Approvals:

AZ/NZS CISPR 32 :2015

This product is not a complete product until fully installed. It is therefore considered a component part of an overall system. The installer is responsible to check that the end installation complies with local regulatory requirements. This equipment forms part of a "fixed installation"

The manufacturer cannot legally offer technical support to non-qualified gate or door installers. End users should employ the services of a professional install company to commission or support this product!

